

ADAM LEVER LATCH HANDLE

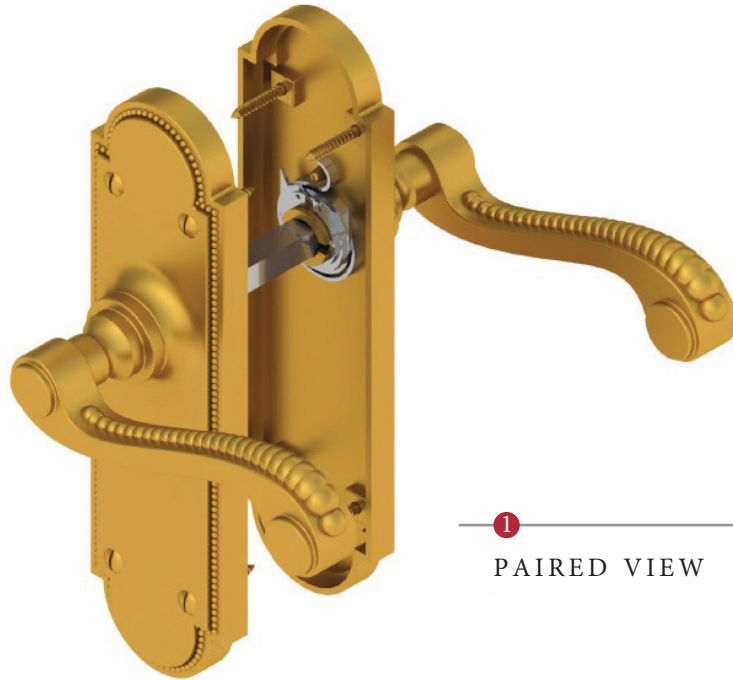

1
PAIRED VIEW

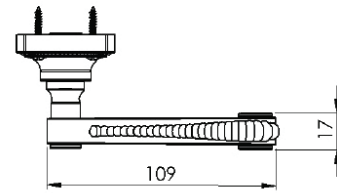
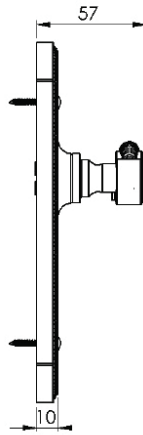
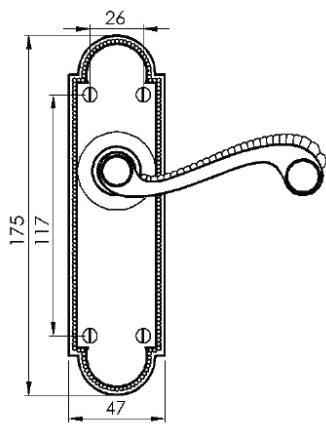

This latch handle is suitable for use with most U.K. tubular latches.
For a new door installation we would recommend using our York standard tubular latch from the list below.

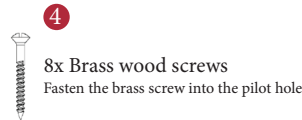
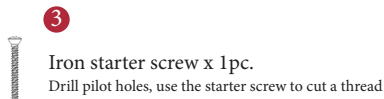
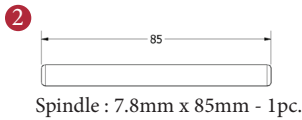

TUBULAR LATCH
(not Included, must be ordered separately)

YKTL2-AT	2 1/2" Antique Finish
YKTL2-BLK	2 1/2" Black Finish
YKTL2-MB	2 1/2" Matt Bronze Finish
YKTL2-PB	2 1/2" Brass Finish
YKTL2-PC&PN	2 1/2" Polished Chrome & Nickel Finish
YKTL2-SB	2 1/2" Satin Brass Finish
YKTL2-SN&SC	2 1/2" Satin Nickel & Chrome Finish
YKTL3-AT	3" Antique Finish
YKTL3-BLK	3" Black Finish
YKTL3-MB	3" Matt Bronze Finish
YKTL3-PB	3" Brass Finish
YKTL3-PC&PN	3" Polished Chrome & Nickel Finish
YKTL3-SB	3" Satin Brass Finish
YKTL3-SN&SC	3" Satin Nickel & Chrome Finish

Box Contains

1	2	3	4
Pair of lever handles	1x 85mm spindle suitable for 35mm & 45mm thick door	1x Iron screw	8x Brass wood screws

M Marcus Ltd., Dudley

Product Code	Material	Available in all Heritage Brass finishes.	Sizes shown are in mm and approximate. We reserve the right to amend where necessary and without any prior notice.
R760	Solid Brass		