

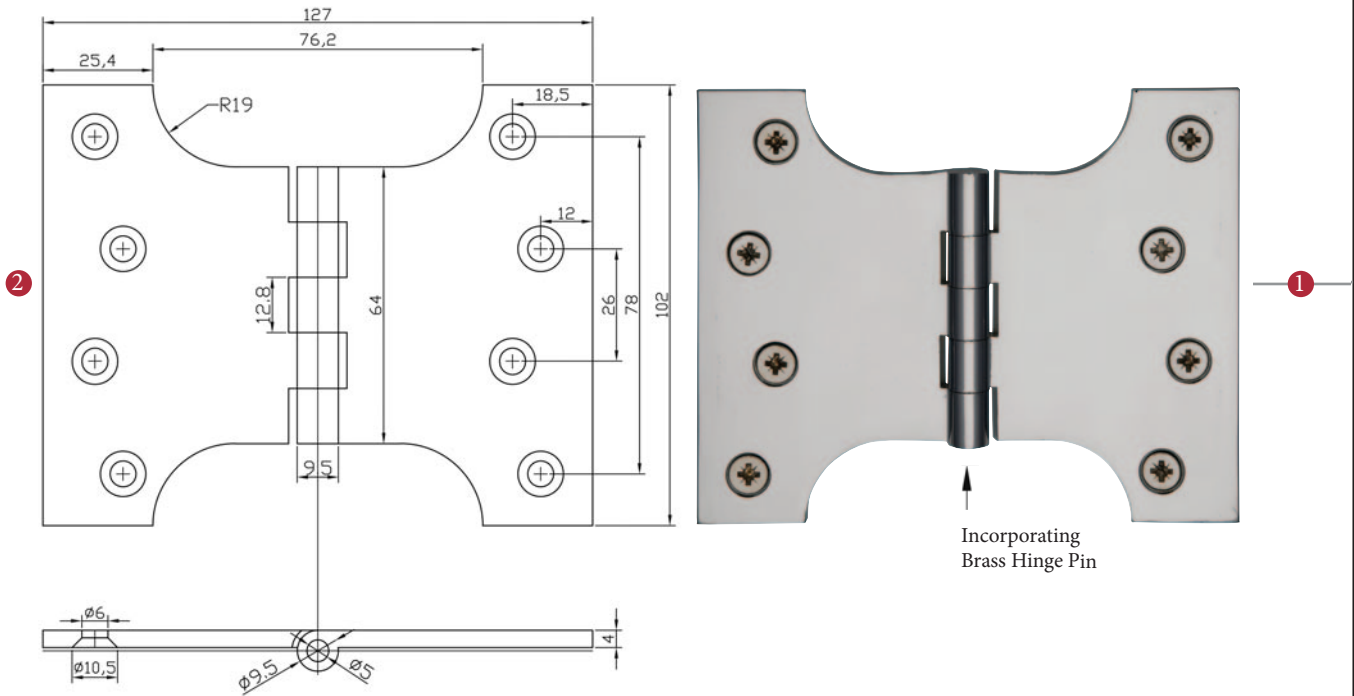





HG99-390 Parliament Hinge [4" x 3" x 5"]



2 Dimensions: see the outlines given above

3  Screw Gauge: No.10 x 1 1/4"

FINISHES

-  Polished Brass finish
-  Polished Chrome finish
-  Antique Brass finish
-  Satin Chrome finish
-  Satin Nickel finish
-  Matt Bronze finish
-  Satin Brass finish

Overview

- 1 Door Hinge illustrated
- 2 General dimensions of Door Hinge
- 3 Supplied with: 16 x 30mm Steel Screws

M Marcus Ltd., Dudley

Product Code

HG99-390

Material

Solid Brass

Available in listed finishes

Sizes shown are in mm and approximate. We reserve the right to amend where necessary and without any prior notice.